

Article number: 203160M863B2S

Description: E+G levelling foot
GN 31-60-M8-63-B2-S

Note: S Without nut, External hexagon at the bottom

Measures

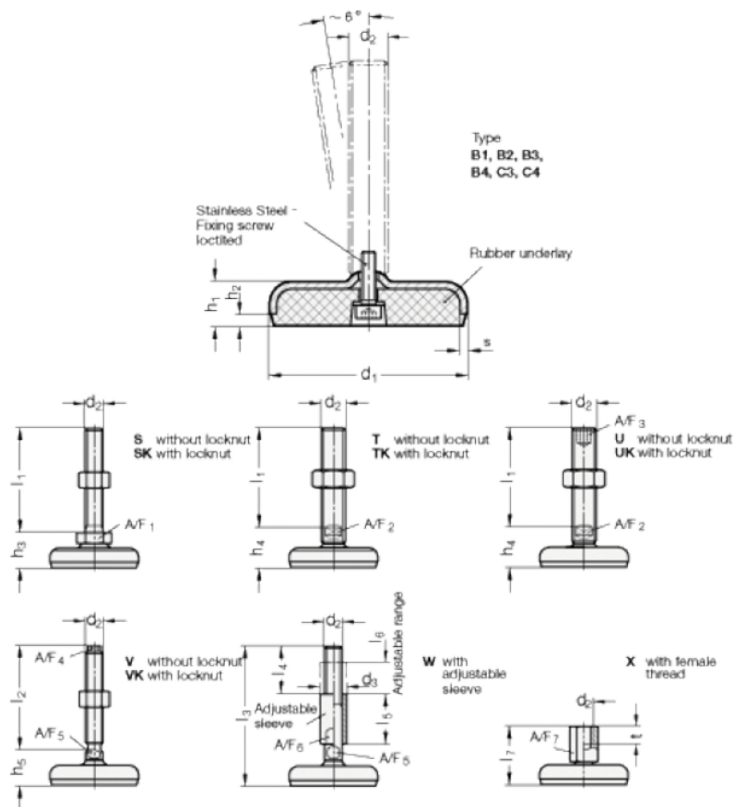

A/F1-	= 17
d1	= 60
d2	= 8
h1	= 16
h2	= 4
h3 +4.0/0	= 26
l1	= 63
s	= 3